

**AXIA**  
UNIQUE KITCHEN



**Chimney Hoods touch screen**  
PERFECT EXTRACTION

**HERO BLACK 90**

Distinguished users:

Thank you for the use of this type of decorative ventilator of the company. The western-style ventilator is luxuriously, artistic, and of great suction. It suits high-grade cabinets. Before the use please read the instruction.





## Contents

I .Structure description.....	2
II .Matters need attention for installation.....	3
III .Method of installation.....	4
IV.Use method.....	6
V.Directions for use.....	7
VI.Maintenance.....	8
VII.Major technique parameters.....	8
VIII.Malfunctions and treatments.....	9
IX.Electric principle scheme.....	9

## IX. Electric principle scheme

### Touch(Remote) control operation



1. Turn on the power, Push button indicating 
2. Push  runs at high speed
3. Push  runs at middle speed
3. Push  runs at low speed
4. Push  lighting on .Push it again the lamps will turn off

## VIII. Malfunctions and treatments

### IX. Electric principle scheme

Number	Faults	Causes	
1	None key works (eg:wind wheel doesn't turn,or lamps arc off)	The plug is not inserted or power cut.	<p><b>Warning</b></p> <p>1. Please pull out the plug while linking the inserter or changing bulbs.</p> <p>2.If the flexible wire is broken, please replace with appropriative flexible wire.(contact with the company)</p> <p>3. Don't allow fire to get into the organism.</p>
2	Lamps are off	The lamps are broken or poor contact.	
3	Creepage	Jacks are not well earth led.	
4	Unusual noise when the impeller is turning	Loose impeller.Loose nut cap.	
5	Waste oil cannot flow into the oil cup	The organism is slopy.	

If you are in trouble or you have suggestion.Please write to the company(The address is on the back cover). Leaving your telephone number.Thank you! If the ventilator has got any fault,Please contact with the dealer, special engaged maintenance point or the service centre.

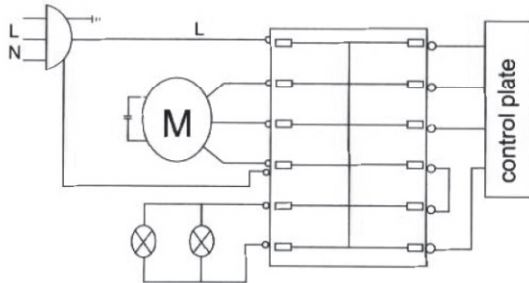

western-style series

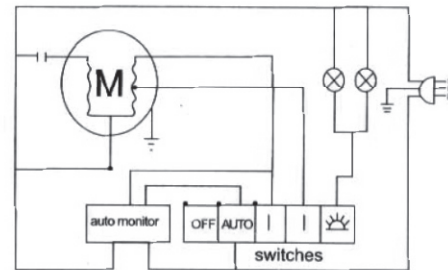

Powerful Series

No announcement for the change of wireways

### I. Structure description

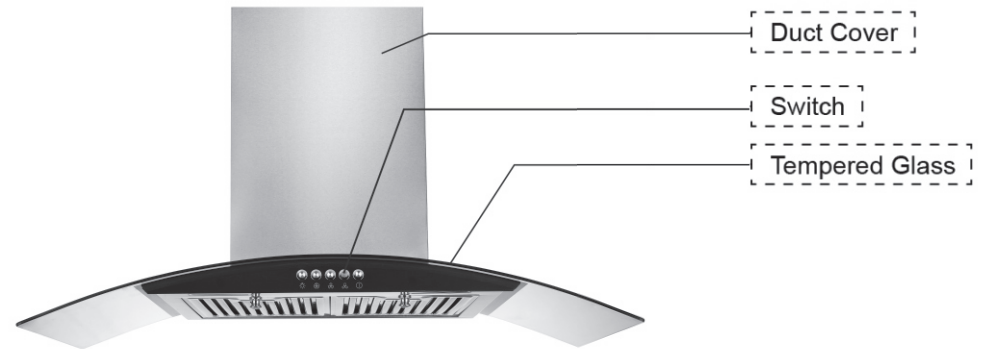

Axia HERO BLACK 90

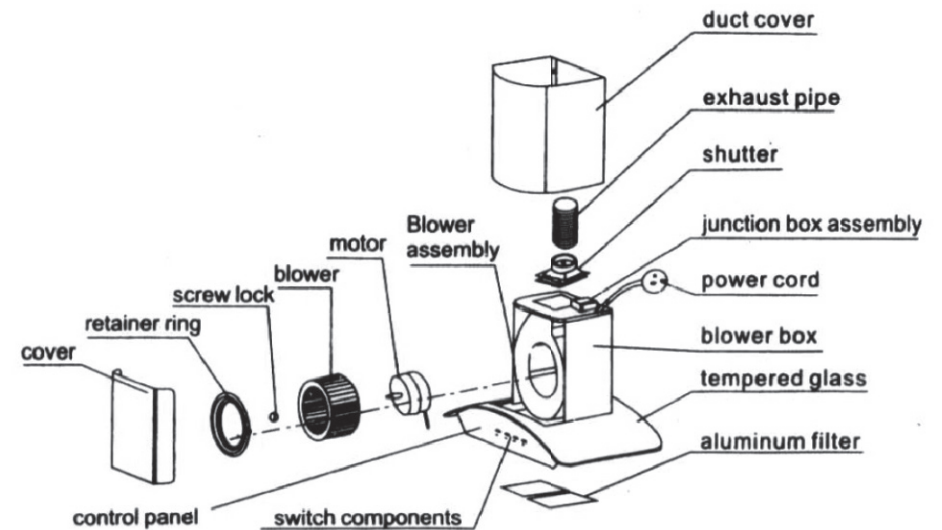

## II. Matters need attention for installation

### 1. Install surroundings (shown in figure 1)

Excessive windows and doors should be avoided around it when the kitchen hood is installed, because when there are too many windows and doors, the air convection is oversized, which enable the lampblack rise to the 250mm effective attraction scope. The efficiency of the kitchen hood comes under the influence.

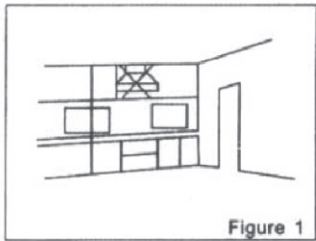

Figure 1

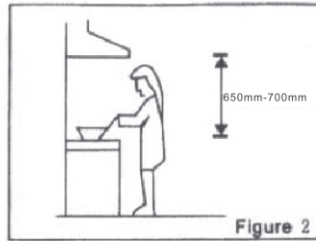

Figure 2

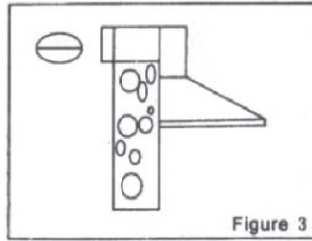

Figure 3

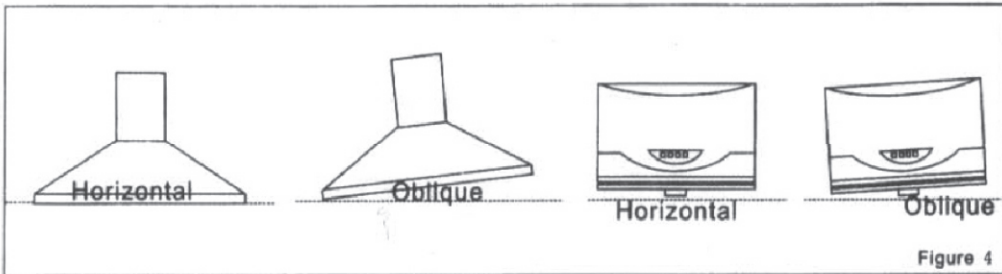

Figure 4

### 2. Ideal location for the installation (shown in figure 2)

The kitchen hood is installed over the cooker hood, the range between the pred stined affinity lowend and the stove surface should be at least 650 mm. Its scope is better to be in 650-700mm.

### 3. Requests for the installation of smoke pipe (shown in figure 3)

(1) The distance from the exit of the smoke pipe to the organism should not be too long. Make the radius of turn as large as possible. Make few curves, or the effect will not be so good.

(2) The exhaust duct should reach outdoor of the common smoke pipe. and the connector must be narrow. Please don't discharge the waste gas into hot flue.

### 4. Keeping the organism level (shown in figure 4)

After the installment, watch out if it's horizontal to avoid the spillover of the oil caused by the oil cup being oblique.

5. The waste gas should not be discharged into the hot flue which is used to discharged the smoke of burning gas or other kinds of fuel.

6. When boring holes, avoid the power cords inside the wall, so as not to get an electric shock, (shown in figure 5)

7. The electric outlet must be earth lead and the plug can't be changed optionally. (shown in figure 6)

8. Proper space (usually about 10mm) should be left on both sides of the organism when making the cabinet. The boards that cover the organism should be turnable so as to be convenient for maintenance and repair (shown in figure 7)

## VI. Maintenance

### VII. Major technique parameters

To make the ventilator works most capably and last long. frequent maintenance should be given. Please pull out the plug while cleaning for security.

1. Keep the exterior of the organism clean, please wipe the exterior often with dry cloth and neutral detergent to keep it tidy and sanitary.

2. Clean the oil filter

(1) Take down the gridding, pour off the waste oil in the inner oil cup, then make it clean and put it back.

(2) The oil filter will look dirty because of the oil stain and begrime. So please clean it once about five days or repace with a new one.

(3) Clean out the oil stain and begrime on the wind wheel and other parts of the organism.

(4) Please don't clean the motor with water.

(5) Pour the waste oil away in the exterior oil cup, then clean it and fix it back.

### VII. Major technique parameters

Model	HERO BLACK 90
Rate Voltage	220~240V 50/60Hz
Rate Power	160W
Lighting Power	2.0WX2
Ventilation Quality	840±60m <sup>3</sup> /h
Weight	20Kg.



## IV. Use method

### V. Directions for use

Figure 19



Leave space for installing the range hood when making the cabinet, thus it will be convenient to maintain or repair the kitchen hood.

Figure 20

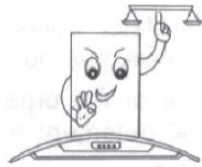

Please keep the organism level while installing

Figure 21

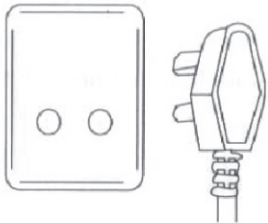

Please use well earth led electric single-phase.

Figure 22

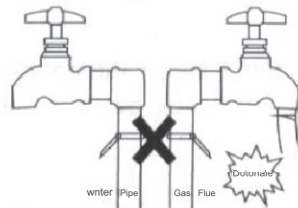

No water pipes and gas flue grounded

## V. Directions for use

- Clean the panel frequently with soft cloth and neutral detergent. Clean the oil filter at least once a month. and clean the oil stain and begime often on the other parts of the organism.
- Attention: Pull out the plug before cleaning. the motor and electric parts cannot be influent. In order to avoid the fire, flammable solvent such as alcohol, amyl, acetate, gasoline are not allowed to be used to clean the kitchen hood.
- The waste gas discharged by the kitchen hood. shouldn't go into the hot flue for burning gas or other kinds of fuel.
- The room must be airy if the kitchen hood when the stove is burning gas or other kinds of fuel.
- The kitchen hood cannot be burnt off by the fire of the stove, other wise the oil cup, Lamp pand and electrical apparatus elements will be burnt.
- Crdeible earthe lead jacks must be used.
- If the flexible wurd is broken, please buy appropriative flexible wire from the manufactory or maintenance service.
- If jacks are not earth- led, have them earth connected, or the kitchen hood cannot be used.
- If it is not cleaned as the instructions, the range hood will be in clanger of fire.
- If it's necessary to change the bulbs;the amount of power cannot be over the rated power.

## III. Method of installation

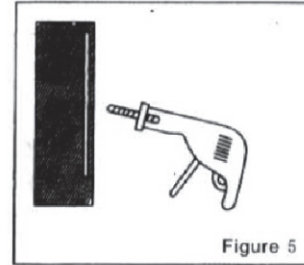

Figure 5

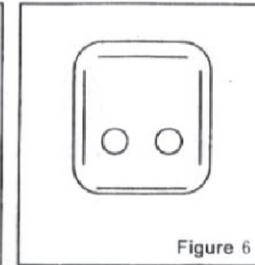

Figure 6

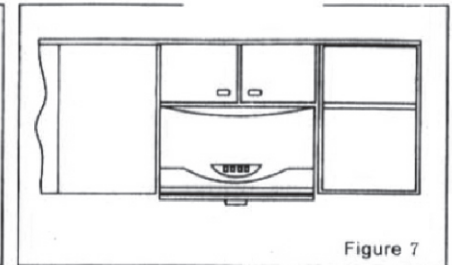

Figure 7

- Determining the location: Install the kitchen hood horizontally above the stove. The bottom of the range hood is about 650mm to 750mm high. The size of the with drawble boards we refer to you is 430mm, which can be adjusted according to actual situation. The open holes must be vertical, centered and horizontal to the organism.
- Installing the cladding: First bore three holes in the dry wall whose diameters are 8mm and depths are 50mm to 60mm. Then put the expansion tube into the holes. At last use the lag wood screcos of the size of ST4X50 in the packing box to set the cladding.
- Adjusting the stretched tube(if there is): pull out the stretched tube, remove the protective layer, put it into the gap between the decorated tube and organism and adjust to the appropriate height.
- Intalling the organism(in figure8). press and slide the pothook on the cladding into the holes at the back of the organism. Rock the organism with the hand to see if it is fastened.
- Fixing the exhaust duct: Insert the exhaust duct between the inside track and the outside track of the air outlet. set with ST3X6 bolt, and put the other end outdoor.
- Fixing the exhaust duct: Insert the exhaust duct into the inside track of the check valve' s air outlet, set with ST3X6 tapping screw and connet the other end outdoor(the air outlet is at the top of the organism).
- Fixing the other end of the exhaust duct <reference>
  - When the exhaust duct and the charging floor are just against the window: Remove a pane of glass and fix a veneer with a hole. You can also make a hole on the glass.
  - When the charging floor is not near the window: Choose the necerest charging floor and the window which can reach outdoor to fix the exhaust duct by going through the window; or choose the nearest charging floor and bore a hole in the wall, then make the exhaust duct go through the wall.
  - Bore a hole in the wall: Measure and draw a circle on the wall(the diameter is a little bigger than that of the exhaust duct) , and bore a hole with long drill, pay attention to the structure and metal of the wall, Don' t destroy the wall surface beyond the hole. The diameter of the hole should be close to the diameter of the exhust duct, or the smoke can not go out smoothly. The noise will be too much and the wind rate will also reduce.

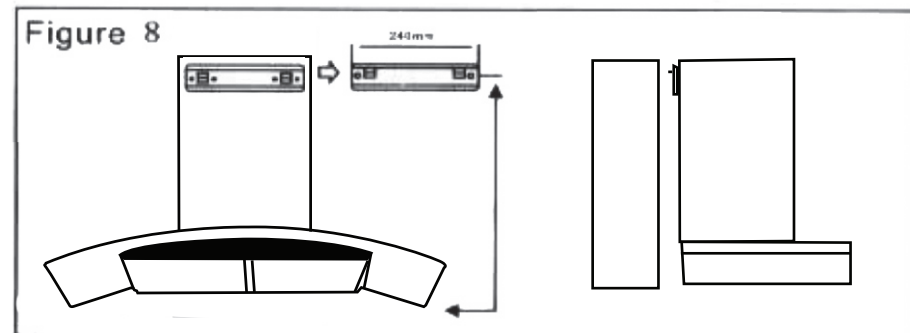
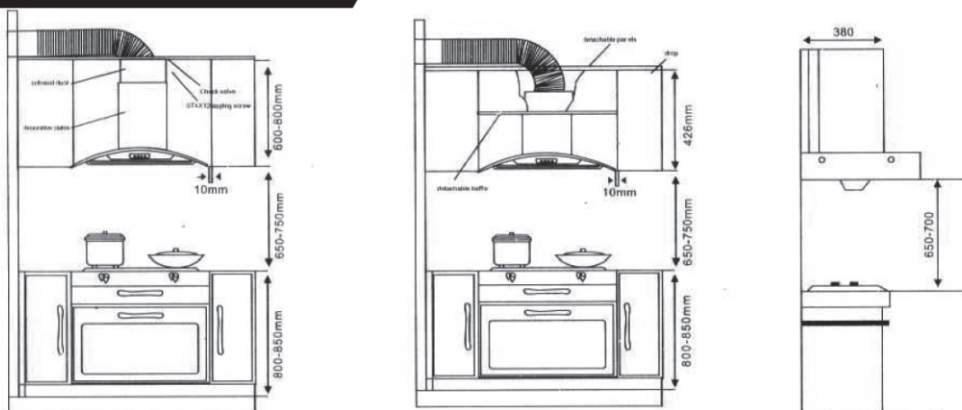

Figure 8

### III. Method of installation



demolition back plate with the installation methods

#### Asia style

##### 1. Boring an air outlet hole:

Make the exhaust duct against the wall, and draw a circle around it, then bore a hole in the wall with a percussion drilling, watch out the structure and metal of the wall so as not to boil the surface of the wall beyond the hole.

##### 2. Installing the organism:

(1) According to the requests shown in figure9 bore a 40-50mm deep hole in the wall above the stove with +8mm drill bit, keep the organism level. The distance between the bottom of the organism and the stove is 700-750mm.

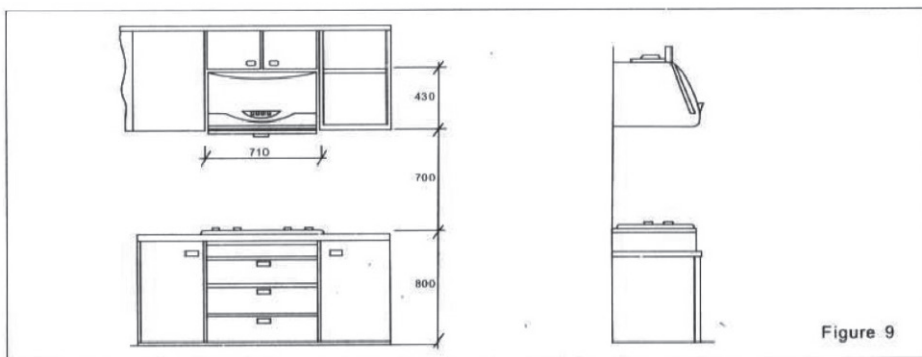

Figure 9

(2) knock two plug bolts slightly into the open holes (shown in figure10), then fit two claddings into plug bolts and wind the nuts, Make sure that the claddings are fastened to avoid that it may drop from the wall.

(3) Set the feet into the openholes at the back of the organism(shown in figure11).

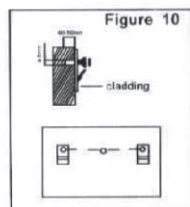

Figure 10

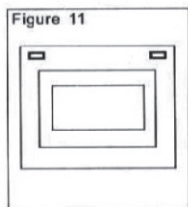

Figure 11

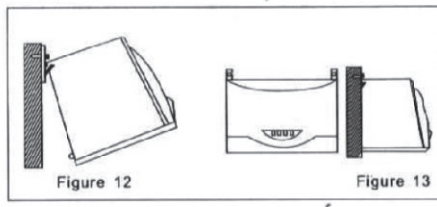

Figure 12

Figure 13

### III. Method of installation

### IV. Use method

(4) Fit the organism into the claddings(shown in figure12)

(5) Fit the textile board into the central expansion bolt and make it close to the organism (shown in figure13)

(6) Insert the exhaust duct into the inside and outside tracks of the air outlet and fix with tapping screw. Insure that the exhaust duct is neither convex nor concave, the CORner piece is smoothly, th'e connector is narrow, and the blades in the air outlet can turn freely. Make a pylome of 170mm diameter at the exit of the exhaust duct, through which the exhust duct can reach outdoor or the common smoke pipe. The connector must be narrow. The waste gas cannot be discharged into the hotflue which is used to discharge the smoke of burning gas or other kinds of fuel.

### IV. Use method

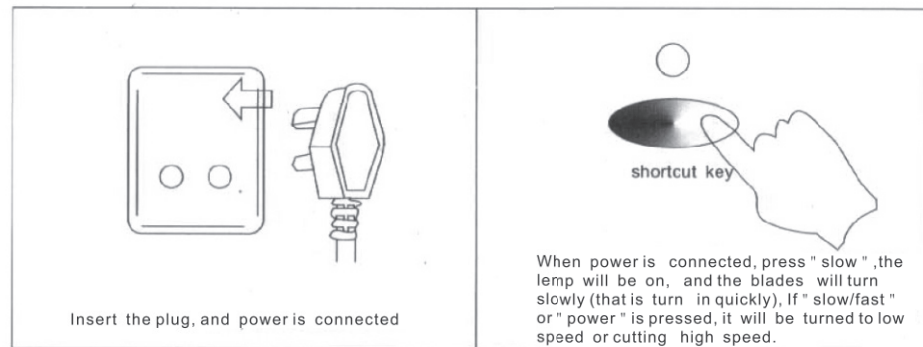
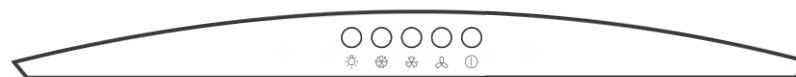

Insert the plug, and power is connected

When power is connected, press "slow", the lamp will be on, and the blades will turn slowly (that is turn in quickly), If "slow/fast" or "power" is pressed, it will be turned to low speed or cutting high speed.

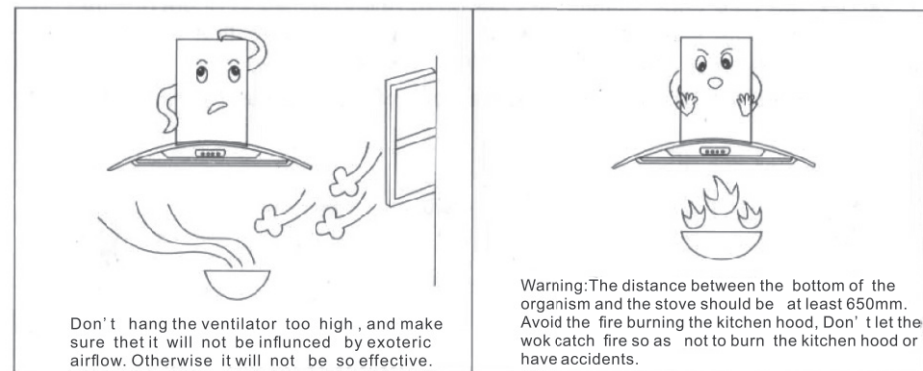

Don't hang the ventilator too high, and make sure that it will not be influenced by exoteric airflow. Otherwise it will not be so effective.

Warning: The distance between the bottom of the organism and the stove should be at least 650mm. Avoid the fire burning the kitchen hood, Don't let the wok catch fire so as not to burn the kitchen hood or have accidents.