

DAILY REFERENCE GUIDE



THANK YOU FOR PURCHASING AN ARISTON PRODUCT

To receive more comprehensive help and support, please register your product at www.aristonchannel.com



You can download the Safety Instructions and the Use and Care Guide by visiting our website www.aristonchannel.com and following the instructions on the back of this booklet.



Before using the appliance carefully read the Health and Safety guide.

PRODUCT DESCRIPTION

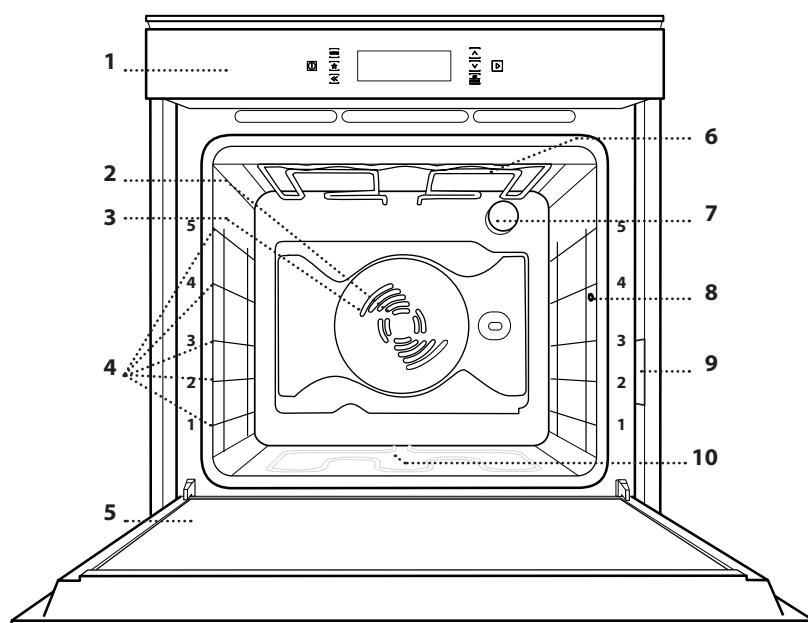

1. Control panel
2. Fan
3. Circular heating element (non-visible)
4. Shelf guides (the level is indicated on the front of the oven)
5. Door
6. Upper heating element/grill
7. Lamp
8. Meat probe connection
9. Identification plate (do not remove)
10. Lower heating element (non-visible)

CONTROL PANEL

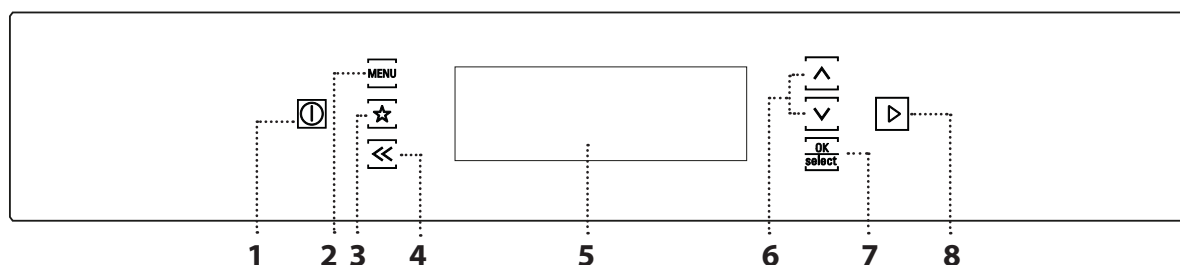

1. ON/OFF

For turning the oven on and off.

2. MENU

For gaining quick access to the main menu.

3. FAVOURITES

To save and quickly retrieve up to 10 favorite functions.

4. BACK

For returning to the previous menu.

5. DISPLAY

For navigating through menus, moving the cursor and changing settings.

7. OK / SELECT

For selecting functions and confirming settings.

8. START

For starting the function that has been selected.

WIRE SHELF

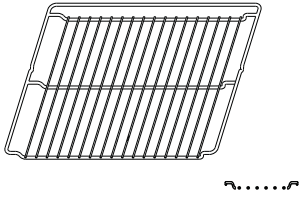

DRIP TRAY

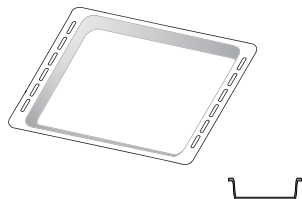

BAKING TRAY

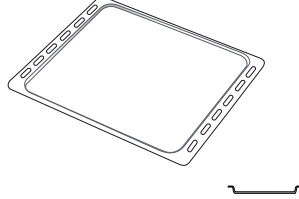

SLIDING RUNNERS

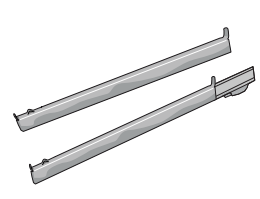

MEAT PROBE

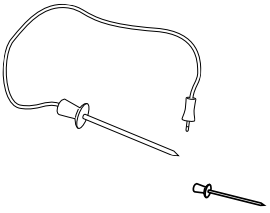

TURNSPIT

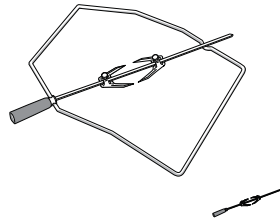

GRILL PAN SET

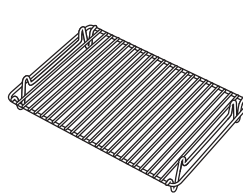

The number of accessories may vary depending on which model is purchased. Other accessories can be purchased separately from the After-sales Service.

INSERTING THE WIRE SHELF AND OTHER ACCESSORIES

Insert the wire shelf horizontally by sliding it across the shelf guides, making sure that the side with the raised edge is facing upwards.

Other accessories, such as the drip tray and the baking tray, are inserted horizontally in the same way as the wire shelf.

FITTING THE SLIDING RUNNERS

Remove the shelf guides from the oven and remove the protective plastic from the sliding runners.

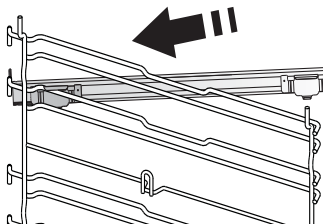

Fasten the upper clip of the runner to the shelf guide and slide it along as far as it will go. Lower the other clip into position.

To secure the guide, press the lower portion of the clip firmly against the shelf guide. Make sure that the runners can move freely. Repeat these steps on the other shelf guide on the same level.

Please note: The sliding runners can be fitted on any level

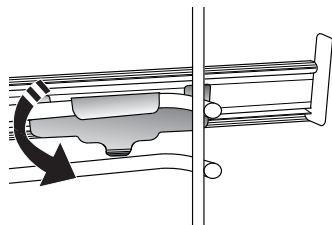

REMOVING AND REFITTING THE SHELF GUIDES

- To remove the shelf guides, lift them up and pull the lower parts out of their lodgings: The shelf guides can now be removed.

- To refit the shelf guides, first fit them back into their upper seating. Keeping them held up, slide them into the cooking compartment, then lower them into position in the lower seating.

USING THE TURNSPIT

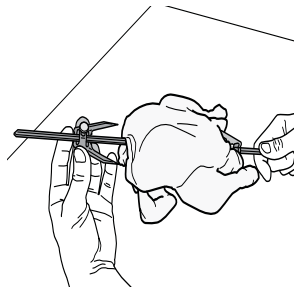

Push the skewer through the centre of the meat (bound with string if poultry) and slide the meat onto the skewer until it is positioned firmly on the fork and cannot move. Push the second fork onto the skewer and slide it on until it holds the meat firmly in place.

Tighten the fixing screw to secure it in position.

Insert the end into the recess provided in the oven's cooking compartment and rest the rounded part on the relevant support.

Please note: To collect the cooking juices, position the drip tray below and add 500 ml of water. To avoid burning yourself when the skewer is hot, only handle it by the plastic handle (which must be removed before cooking).

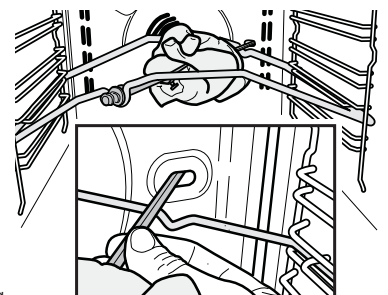

**TRADITIONAL****FAST PREHEATING**

For preheating the oven quickly.

**CONVENTIONAL**

For cooking any kind of dish on one shelf only.

**GRILL**

For grilling steaks, kebabs and sausages, cooking vegetables au gratin or toasting bread. When grilling meat, we recommend using a drip tray to collect the cooking juices: Position the pan on any of the levels below the wire shelf and add 500 ml of water.

**TURBO GRILL**

For roasting large joints of meat (legs, roast beef, chicken). We recommend using a drip tray to collect the cooking juices: Position the pan on any of the levels below the wire shelf and add 500 ml of water. The turnspit (if provided) can be used with this function.

**FORCED AIR**

For cooking different foods that require the same cooking temperature on several shelves (maximum three) at the same time. This function can be used to cook different foods without odours being transferred from one food to another.

**CONVECTION BAKE**

For cooking meat or baking cakes with liquid centre on a single shelf.

**SPECIAL FUNCTIONS****DEFROST**

For defrosting food more quickly.

**KEEP WARM**

For keeping just-cooked food hot and crisp.

**RISING**

For helping sweet or savoury dough to rise effectively. To maintain the quality of proving, do not activate the function if the oven is still hot following a cooking cycle.

**CONVENIENCE**

The function cooks all kinds of dishes quickly and gently. It can also be used to reheat food that has already been cooked and then stored at room temperature or in the refrigerator.

**MAXI COOKING**

For cooking large joints of meat (above 2.5 kg). We recommend turning the meat over during cooking to ensure that both sides brown evenly. We also recommend basting the joint every so often to prevent it from drying out excessively.

**FROZEN FOOD**

Lasagne - pizza - strudel - French fries - bread. This function automatically selects the optimum cooking temperature and cooking mode for five different types of frozen convenience food. Select "Custom" to set the temperature for other types of products.

**SLOW COOKING**

For cooking meat and fish gently while keeping them tender and succulent. We recommend searing roasting joints in a pan first to brown the meat and help seal in its natural juices. Cooking times range from two hours for fish weighing 300 g to four or five hours for fish weighing 3 kg, and from four hours for joints of meat weighing 1 kg to six or seven hours for joints of meat weighing 3 kg.

**ECO FORCED AIR**

For cooking stuffed roasting joints and fillets of meat on a single shelf. Food is prevented from drying out excessively by gentle, intermittent air circulation. When this function is in use, the ECO light will remain switched off throughout cooking. To utilize ECO cycle thus reducing energy consumption, oven door should not be opened till completion of cooking recipe.



AUTOMATIC CLEANING - PYRO

For eliminating cooking spatters using a cycle at very high temperature (approx. 500 °C). Two selfcleaning cycles are available: A complete cycle (PYRO) and a shorter cycle (PYRO EXPRESS). We recommend using the quicker cycle at regular intervals and the complete cycle only when the oven is heavily soiled.



SETTINGS

For changing the oven settings (language, time, audible signal volume, brightness, Eco mode).

Please note: When the oven is switched off but Eco mode is active, the brightness of the display will be reduced to save energy.



FULLY AUTOMATIC RECIPES

To make sure that you use this function correctly, read and download our recipe book from www.aristonchannel.com For selecting one of 28 different preset recipes. The oven will set the optimum cooking temperature, function and time automatically.



MEAT PROBE RECIPES

This function automatically selects the optimum cooking mode for various different types of meat. It will suggest an optimum temperature for both the cooking compartment and the inside of the food depending on which type of meat is selected. To make sure that you insert and use the probe correctly, follow the instructions given in the relevant paragraph.

USING THE APPLIANCE FOR THE FIRST TIME

1. PLEASE SELECT LANGUAGE

You will need to set the language and the time when you switch on the appliance for the first time: The display will show you a list of available languages.

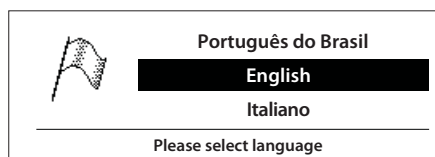

Press **▲** or **▼** to display the language you require and confirm by pressing **OK select**

Please note: The language can also be changed later from the "Settings" menu item.

2. SET THE TIME

After selecting the language, you will need to set the current time: 12:00 will flash on the display.

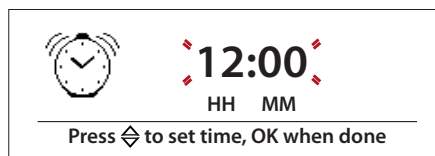

Use **▲** or **▼** to set the time and confirm by pressing **OK select**

Please note: The time will always need to be reset following a power cut.

3. HEAT THE OVEN

A new oven may release odours that have been left behind during manufacturing: This is completely normal.

Before starting to cook food, we therefore recommend heating the oven with it empty in order to remove any possible odours.

Remove any protective cardboard or transparent film from the oven and remove any accessories from inside it. Heat the oven to 200 °C for around one hour, ideally using a function with air circulation (e.g. "Forced Air" or "Convection Bake").

Follow the instructions for setting the function correctly.

Please note: It is advisable to air the room after using the appliance for the first time.

DAILY USE

1. SELECT A FUNCTION

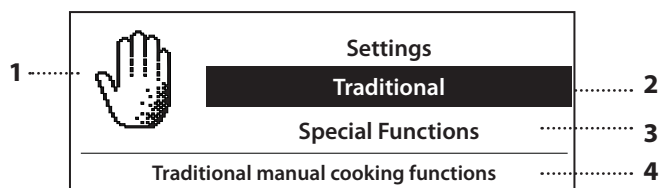

1. Symbol for the function selected
2. Function selected
3. Other available functions
4. Description of the function selected

SWITCH ON THE OVEN

Press and hold : The display will show the main menu.

NAVIGATE THE MENU

Press or to navigate through the main menu and highlight the item you would like to select.

SELECT AN ITEM FROM THE MENU

Once the item you would like to select is highlighted on the display, press to confirm the selection and go to the settings menu (see below) or to the list of functions.

SELECT A FUNCTION

Press or to navigate through the list on screen. Press to confirm and go to the settings menu.

2. SETTING AND ACTIVATING A FUNCTION

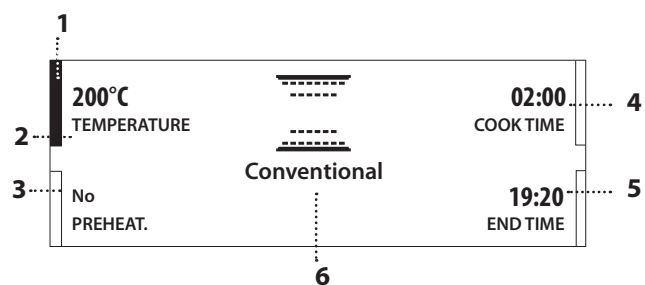

1. Cursor (highlights the setting selected)
2. Temperature/grill power
3. Preheating
4. Duration
5. Time at which the function will finish
6. Name of the function

APPLY SETTINGS

Press or to move the cursor onto the settings that you can modify.

Once the cursor is in position, change the setting by pressing : The setting you have selected will start to flash.

Use or to change the value and press to confirm.

ACTIVATE THE FUNCTION

Once the settings displayed are those that you require, press to activate the function. Place the food in the oven and then press again to activate the function.

Please note: Some settings can also be changed during cooking.

3. PREHEATING

This oven can cook any type of food with or without a preheating phase.

Selecting "No" will reduce the overall cooking time (including preheating) and energy consumption by up to 25%.

Preheating can be activated with the majority of functions.

Once preheating has finished, an audible signal will sound to indicate that the oven has reached the set temperature.

Place the food inside and proceed with cooking.

Please note: Placing the food in the oven before preheating has finished may have an adverse effect on the final cooking result.

4. SETTING THE END COOKING TIME (DELAYED START)

Many functions allow you to postpone the start of cooking by setting the end time.

When setting the length of time for the function to run, the display will show what time cooking is expected to be complete. Use or to move the cursor to END TIME and press : The time will flash.

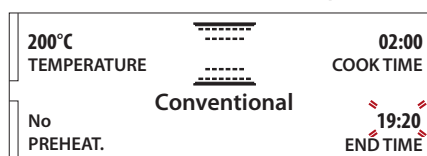

Use or to select the time you require cooking to end and press . Press and place the food in the oven, then press again to activate the function.

The oven will switch on automatically after the period of time that has been calculated in order for cooking to end at the time you have set.

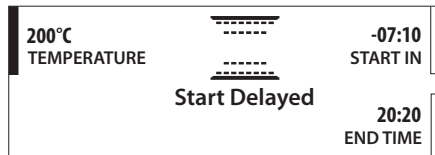

Please note: You can activate this function immediately and cancel the waiting time by pressing **▷**. This setting can only be applied if preheating of the oven is not required.

. BROWNING

Some functions of the oven enable you to brown the surface of the food by activating the grill once cooking is complete.



If required, press **OK select** to activate a five-minute browning cycle. Cooking using the function that is currently selected can also be extended by pressing **▲**.

To stop the browning function, press **⓪** to switch off the oven or press **MENU** to access the main menu.

. FULLY AUTOMATIC RECIPES **[[⬅➡]]**

The oven has 28 fully automatic recipes in which the optimum functions and cooking temperatures are preset. To make the most of this function and achieve the optimum cooking results, read and download our recipe book from www.aristonchannel.com

Select "Recipes" from the main menu using **▲** or **▼**. Press **OK select** to confirm and access the list of available dishes.

Use **▲** or **▼** to scroll through the list, then press **OK select** to confirm your selection.



Press **▷** and place the food in the oven. Press **▷** again to activate the function. These recipes allow you to set an end cooking time.

Please note: An audible signal will sound and the display will indicate what actions the selected function needs you to take and when, e.g. turning the food or checking the progress of cooking.

. MEAT PROBE RECIPES **⏏**

Using the meat probe enables you to measure the core temperature of the food during cooking. Use **▲** or **▼** to select "Meat Probe Recipes" from the main menu and press **OK select**. Select the dish you want from the list available and press **OK select** to confirm.

Please note: Selecting "Custom Meat" allows you to alter all of the settings (for the temperature of the oven and the temperature of the probe). The other recipes only allow you to change some of the settings.

Insert the probe deep into the meat, avoiding bones or fatty areas. For poultry, insert the probe lengthways into the centre of the breast, avoiding hollow areas. Place the food in the oven and connect the plug by inserting it into the connection provided on the right-hand side of the oven's cooking compartment.

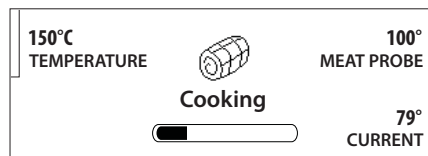
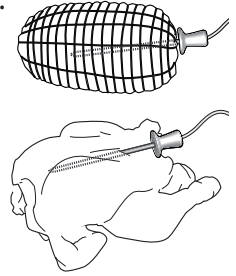

Change (if possible) the preset settings as required or press **▷**. An audible signal will sound and the display will indicate when the food probe has reached the required temperature.

Once cooking is complete, the result can be perfected by extending the cooking time.

Press **▲** or **▼** to set the length of time: The oven will use the "Conventional" function automatically.

Please note: An audible signal will sound and a message will appear if the probe has not been connected correctly.

USING THE MEAT PROBE WITH MANUAL FUNCTIONS

The meat probe can also be used with some of the manual functions to achieve optimal results when cooking meat.

Select a manual function and connect the probe: The top left of the display will show the temperature for the probe to reach.

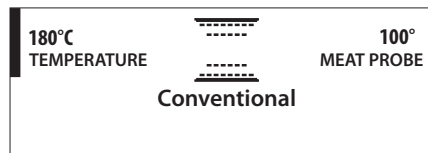

To change this setting, use **▲** or **▼** to move the cursor next to the value and press **OK select**. When the setting starts flashing on the display, set the value you require using **▲** or **▼** and then press **OK select** to confirm.

To obtain a table showing the temperatures recommended for each type of meat, read and download the Use and Care Guide at www.aristonchannel.com



. FAVOURITES

To make the oven easier to use, it can save up to 10 of your favourite functions.

If you would like to save a function as a favourite and store the current settings for future use, press ☆ once cooking is complete.

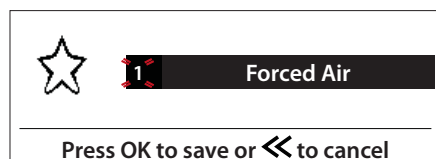
Press  to confirm: The display will prompt you to save the function in a number between 1 and 10 on your list of favourites.







Use  or  to select the number, then conform by pressing .

Please note: Press  to cancel.

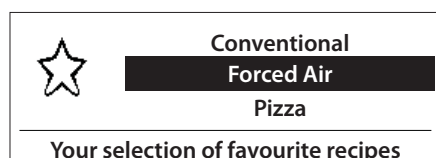
If the memory is full or the number has already been taken, the function will be overwritten.

To call up the functions you have saved at a later time, press ☆: The display will show your list of favourite functions.





Use  or  to select the function, confirm by pressing , and then press  to activate.

. TIMER

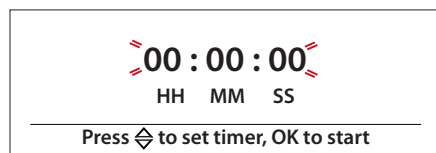

When the oven is switched off, the display can be used as a timer. To activate the function, make sure that the oven is switched off and then press : The timer will flash on the display.



Use  or  to set the length of time you require and then press  to activate the timer. An audible signal will sound once the timer has finished counting down the selected time.

Please note: You can stop the timer at any time by pressing .

. KEY LOCK

To lock the keypad, press and hold  and  at the same time for at least five seconds. Do this again to unlock the keypad.



Please note: This function can also be activated during cooking.

For safety reasons, the oven can be switched off at any time by pressing the  button.

. AUTOMATIC CLEANING – PYRO

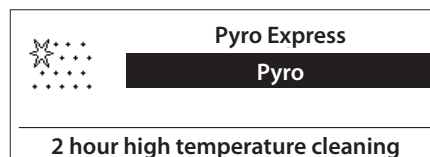
Use  or  to select “Cleaning” from the main menu and press .



Select “Pyro” or “Pyro Express” from the menu and press : The display will show the length of the selected cycle and the time it will end. Press the  button: The display will show the instructions to follow to start the cleaning cycle.

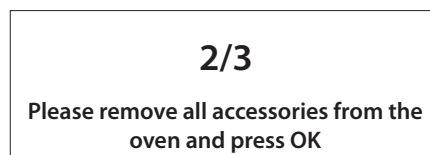

Take particular care to remove all the accessories from the oven before cleaning, including the shelf guides.

Once you have followed each instruction, press  to proceed to the next step.

Upon the final confirmation, the oven will start the cleaning cycle and the door will be locked automatically: A message will immediately appear on the display showing a progress bar to indicate how the cleaning cycle is progressing.

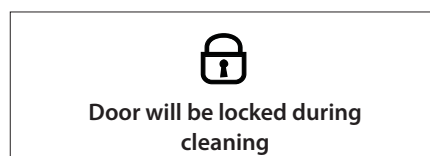

An appropriate message will start flashing on the display once the cycle has finished. The residual temperature will be indicated in the display and the door will remain locked until the temperature inside the oven has returned to a safe level. The display will then show the current time.

COOKING TABLE

RECIPE	FUNCTION	PREHEAT	TEMPERATURE (°C)	COOK TIME (Min.)	LEVEL AND ACCESSORIES
Leavened cakes		-	160-180	30-90	2/3
		-	160-180	30-90	4 1
Filled cake (cheesecake, strudel, fruit tart)		-	160-200	35-90	3
		-	160-200	40-90	4 1
Biscuits/tartlets		-	160-180	20-45	3
		-	160-170	20-45	4 1
		-	160-170	20-45 ***	5 3 1
Choux buns		-	180-200	30-40	3
		-	180-190	35-45	4 1
		-	180-190	35-45 ***	5 3 1
Meringues		-	90	110-150	3
		-	90	140-160	4 1
		-	90	140-160 ***	5 3 1
Bread/pizza/focaccia		-	190-250	15-50	1 / 2
		-	190-250	20-50	4 1
		-	190-250	25-50 ***	5 3 1
Salty cakes (vegetable pie, quiche)		-	180-190	40-55	2 / 3
		-	180-190	45-70	4 1
		-	180-190	45-70 ***	5 3 1
Vols-au-vents/puff pastry crackers		-	190-200	20-30	3
		-	180-190	20-40	4 1
		-	180-190	20-40 ***	5 3 1
Lasagne/baked pasta/cannelloni/flans		-	190-200	45-65	3
Lamb/veal/beef/pork 1 kg		-	190-200	80-110	3
Chicken/rabbit/duck 1 kg		-	200-230	50-100	3
Turkey/goose 3 kg		-	190-200	80-130	2
Baked fish/en papillote (fillet, whole)		-	180-200	50-60	3
Stuffed vegetables (tomatoes, courgettes, aubergines)		-	180-200	40-60	2
Toasted bread		-	High	3-6	5

RECIPE	FUNCTION	PREHEAT	TEMPERATURE (°C)	COOK TIME (Min.)	LEVEL AND ACCESSORIES
Fish fillets/slices		-	Medium	20-30 *	4 3
Sausages/kebabs/ spare ribs/hamburgers		-	Medium - High	15-30 *	5 4
Roast chicken 1-1.3 kg		-	Medium	55-70 **	2 1
Roast chicken 1-1.3 kg		-	High	60-80	2 1
Roast beef rare 1 kg		-	Medium	35-50 **	3
Leg of lamb/knuckle		-	Medium	60-90 **	3
Roast potatoes		-	Medium	35-55 **	3
Vegetable gratin		-	High	10-25	3
Lasagne and meat		-	200	50-100 ***	4 1
Meat and potatoes		-	180	45-100 ***	4 1
Fish and vegetables		-	190	30-50 ***	4 1
Complete meal: Fruit tart (level 5)/ lasagne (level 3)/meat (level 1)		-	190	40-120 ***	5 3 1
Frozen pizza		-	Auto	10-15	3
		-	Auto	15-20	4 1
		-	Auto	20-30	4 2 1
		-	Auto	20-30	4 3-2 1
Stuffed roasting joints		-	200	80-120 ***	3
Cuts of meat (rabbit, chicken, lamb)		-	200	50-100 ***	3

* Turn food halfway through cooking.

** Turn food two thirds of the way through cooking (if necessary).

*** Estimated length of time: Dishes can be removed from the oven at different times depending on personal preference.

www.aristonchannel.com Download the Use and Care Guide from www.aristonchannel.com for the table of tested recipes, compiled for the certification authorities in accordance with the standard IEC 60350-1.

www.aristonchannel.com Download the Use and Care Guide from www.aristonchannel.com for the table of recipes requiring use of the meat probe.

FUNCTIONS							
	Conventional	Grill	Turbo Grill	Forced Air	Convection Bake	Defrost	Eco Forced Air
ACCESSORIES							
	Wire shelf	Ovenware or baking pan on the wire shelf	Drip tray / baking tray	Drip tray	Drip tray with 500 ml of water	Baking tray	Turnspit
							Meat probe (optional)

MAINTENANCE AND CLEANING



Download the Use and Care Guide from www.aristonchannel.com for more information

Make sure that the oven has cooled down before carrying out any maintenance or cleaning.

Do not use steam cleaners.

Do not use wire wool, abrasive scourers or abrasive/corrosive cleaning agents, as these could damage the surfaces of the appliance.

Wear protective gloves.

The oven must be disconnected from the mains before carrying out any kind of maintenance work.

EXTERIOR SURFACES

- Clean the surfaces with a damp microfibre cloth. If they are very dirty, add a few drops of pH-neutral detergent. Finish off with a dry cloth.
- Do not use corrosive or abrasive detergents. If any of these products inadvertently comes into contact with the surfaces of the appliance, clean immediately with a damp microfibre cloth.

INTERIOR SURFACES

- After every use, leave the oven to cool and then clean it, preferably while it is still warm, to remove any deposits or stains caused by food residues.

To dry any condensation that has formed as a result of cooking foods with a high water content, leave the oven to cool completely and then wipe it with a cloth or sponge.

- Clean the door glass with a suitable liquid detergent.
- The oven door can be removed to facilitate cleaning.

ACCESSORIES

Soak the accessories in a washing-up liquid solution after use, handling them with oven gloves if they are still hot. Food residues can be removed using a washing-up brush or a sponge.

CLEANING THE COOKING COMPARTMENT WITH THE PYRO CYCLE

Do not touch the oven during the Pyro cycle.

Keep children and animals away from the oven during and after (until the room has finished airing) running the Pyro cycle.

This function enables you to eliminate cooking spatters using a temperature of approx. 500 °C. At this temperature, food residues turn into deposits that can be easily wiped away with a damp sponge once the oven has cooled down.

If the oven is installed below a hob, make sure that all the burners or electric hotplates are switched off while running the self-cleaning cycle.

Remove all accessories from the oven before running the Pyro function (including the shelf guides).

For optimum cleaning results, remove the worst soiling with a damp sponge before using the Pyro function.

Then oven has two different pyrolytic cleaning functions: The standard cycle (PYRO) provides thorough cleaning if the oven is heavily soiled, while the economic cycle (PYRO EXPRESS) is shorter and consumes less energy than the standard cycle, which makes it suitable for use at regular intervals. Only run the Pyro function if the appliance contains heavy soiling or gives off bad odours during cooking.

Please note: The oven door cannot be opened while pyrolytic cleaning is in progress. It will remain locked until the temperature has returned to an acceptable level.

Air the room during and after running the Pyro cycle.

REPLACING THE LIGHT

1. Disconnect the oven from the power supply.
2. Unscrew the cover from the light, replace the bulb and screw the cover back on the light.
3. Reconnect the oven to the power supply.

Please note: Only use 25-40 W/230 V type E-14, T300 °C incandescent bulbs, or 20-40 W/230 V type G9, T300 °C halogen bulbs. The bulb used in the product is specifically designed for domestic appliances and is not suitable for general room lighting within the home (EC Regulation 244/2009). Light bulbs are available from our After-sales Service.

- If using halogen bulbs, do not handle them with your bare hands as your fingerprints could cause damage. Do not use the oven until the light cover has been refitted.

REMOVING AND REFITTING THE DOOR

1. To remove the door, open it fully and lower the catches until they are in the unlock position.

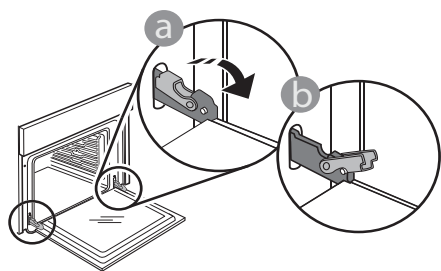

2. Close the door as much as you can. Take a firm hold of the door with both hands – do not hold it by the handle.

Simply remove the door by continuing to close it while pulling it upwards at the same time until it is released from its seating. Put the door to one side, resting it on a soft surface.

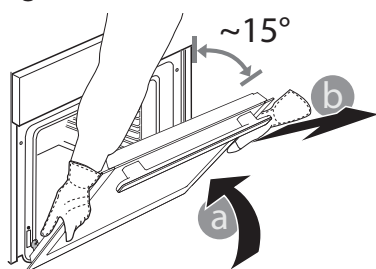

3. Refit the door by moving it towards the oven, aligning the hooks of the hinges with their seating and securing the upper part onto its seating.

4. Lower the door and then open it fully. Lower the catches into their original position: Make sure that you lower them down completely.

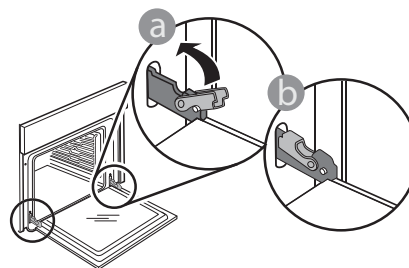

Apply gentle pressure to check that the catches are in the correct position.

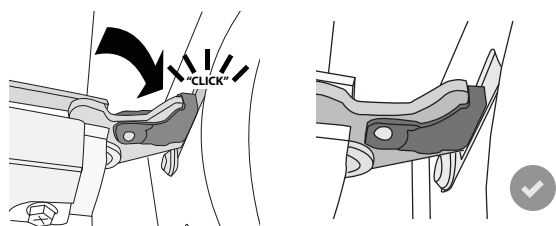

5. Try closing the door and check to make sure that it lines up with the control panel. If it does not, repeat the steps above: The door could become damaged if it does not work properly.

TROUBLESHOOTING



Download the Use and Care Guide from www.aristonchannel.com for more information

Problem	Possible cause	Solution
The oven is not working.	Power cut. Disconnection from the mains.	Check for the presence of mains electrical power and whether the oven is connected to the electricity supply. Turn off the oven and restart it to see if the fault persists.
The door will not open.	Fault with the door lock. Cleaning cycle in progress.	Switch the oven off and on again to see if the fault persists. Wait for the function to finish and for the oven to cool down.
The display shows the letter "F" followed by a number.	Software problem.	Contact your nearest Client After-sales Service Centre and state the number following the letter "F".

USEFUL TIPS



Download the Use and Care Guide from www.aristonchannel.com for more information

HOW TO READ THE COOKING TABLE

The table lists the best function, accessories and level to use to cook various different types of food. Cooking times start from the moment food is placed in the oven, excluding preheating (where required). Cooking temperatures and times are approximate and depend on the amount of food and the type of accessory used. Use the lowest recommended settings to begin with and, if the food is not cooked enough, then switch to higher settings. Use the accessories supplied and preferably dark-coloured metal cake tins and baking trays. You can also use Pyrex or stoneware pans and accessories, but bear in mind that cooking times will be slightly longer.

COOKING DIFFERENT FOODS AT THE SAME TIME

The "Forced Air" function enables you to cook different foods (such as fish and vegetables) on different shelves at the same time. Remove the food which requires a shorter cooking time and leave the food which requires a longer cooking time in the oven.

PRODUCT FICHE

The product fiche with energy data of this appliance can be downloaded from the website www.aristonchannel.com

HOW TO OBTAIN THE USE AND CARE GUIDE

> Download the Use and Care guide from the website www.aristonchannel.com (you can use this QR code), specifying the product's commercial code.



> Alternatively, contact our Client After-sales Service.

CONTACTING OUR AFTER-SALES SERVICE

You can find our contact details in the warranty manual. When contacting our Client After-sales Service, please state the codes provided on your product's identification plate.

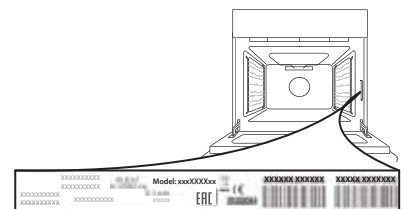

400010900892

Printed in Italy